



# 2023 WHOLESALE SUPPLY CATALOG

CUSTOM MANUFACTURING AND DISTRIBUTION SOLUTIONS

WIRELESS | TELECOM | GROUNDING | ELECTRICAL

# LEADERS IN ADAPTING TO THE EVER CHANGING WIRELESS TELECOM AND ELECTRICAL INDUSTRY.

In the rapidly changing environments of the telecommunication and electrical markets, Izzy Industries and Izzy Lugs are leading the way with custom manufacturing and distribution solutions. Both firms are steadfast in their mission to provide quality products and services that enhance your bottom lines and deliver true value.



P E M B R O K E , N E W H A M P S H I R E

603-546-7117

909-855-3502

[www.IzzyIndustries.com](http://www.IzzyIndustries.com)

[www.IzzyLugs.com](http://www.IzzyLugs.com)

# PRODUCT INDEX

5

## PIM Mitigation

- PIM Universal Stand-Off Adapters
- PIM Acetal Cable Straps

7

## Cable Attachment

- Stackable Snap-In Hangers
- Butterfly Hangers
- Anchor Rail Adapters
- Angle Adapters
- Stand Off Adapters
- 3 Ways
- Hose Clamps
- Clamp Heads
- Coax Support Blocks
- Coax Block Hardware
- PVC Sleepers
- Vinyl Threaded Safety Caps
- Universal Barrel Cushions
- Hanger Adapters
- Hoisting Grips
- Stainless Steel Banding
- Zip Ties
- Cable Tie Wraps
- Stainless Steel Hardware
- Stringer End Caps

22

## Small Cable Management

- Fiber Tags
- Cable Clamps

23

## DAS/RF Components

- RET Cable Assemblies
- Dummy Loads
- Low Pim Test Termination Loads
- Nex10 Termination Loads
- PIM Rated RF Jumpers
- Low Pim Coaxial Adapters
- Fiber Cleaning Accessories

30

## Cable Entry

- Boot Assemblies
- Cushion Inserts
- Port Panels

34

## Weatherproofing

- PVC Tape
- Enclosures
- Silicone Cold Shrink Kit
- Port Protection Caps

37

## Heat Shrink

- Heat Shrink Rolls
- Heat Shrink
- Heavy Duty Marine Grade
- Clear Heat Shrink

39

## Ground Kits

- Tinned Snap In Ground Kit
- Universal Tinned Ground Kit
- Mini Universal Ground Kit

40

## Steel Products

- Galvanized U-Bolt Assemblies
- Galvanized J-Bolt Assemblies
- Galvanized V-Clamps
- Galvanized C-Clamps
- Pipe-to-Pipe Clamps
- Crossover Plates
- Crossover Plate Assemblies
- Support Brackets
- Trapeze Kit
- Grip Strut
- Waveguide Bridge Supports
- Waveguide Ladder Rungs
- Galvanized Z Brackets
- Ice Bridge Kits
- Cable Ladder Hardware Kits

47

## Strut and Accessories

- Strut
- Galvanized Spring Nuts
- Strut End Caps
- Pipe and Conduit Clamps
- Galvanized Square Washers
- Anchor Rail Adapters

52

## Grounding

- Lugs
- Cable Tray Jumpers
- Custom Buss Bars
- Buss Bars
- Galvanized Buss Bars
- Theft Deterrent Kit
- Rack Mount Buss Bar Hardware Kit
- Exothermic Weld Metal
- Steel Disks
- Exothermic Molds
- IzzyWeld Exothermic Starter Kit
- Handles and Accessories

Thank you for choosing Izzy Industries and Izzy Lugs for your wireless telecom, grounding and electrical supplies. We work diligently to provide a wide assortment of products that are high on value and deliver excellent quality. Our goal is to work to help you maximize profits while providing the highest level of quality and service possible. We'll work hard to earn your business. We'll work even harder to keep it.

Our 2023 catalog features an expanded product line with more products focused on 5G, DAS, and small cell areas. As the wireless industry changes Izzy Industries changes with it to help you our customer with a greater assortment of high value products. We've listened to your feedback and have included additional products to provide even more savings and convenience. If there is a product that you need, and do not see, please contact us as we are constantly adding new products to our existing lines. You can also find our products at [www.IzzyIndustries.com](http://www.IzzyIndustries.com) and [www.IzzyLugs.com](http://www.IzzyLugs.com).

We love hearing your feedback, so please feel free to send us your comments at [Scott@IzzyLugs.com](mailto:Scott@IzzyLugs.com).

Thanks for your continued business and support. We appreciate it.



Scott Johnson  
909-855-3502

**PATENT AND UL LISTED PRODUCTS**  
**PRIVATE LABEL PRODUCTS**  
**PRODUCT CUSTOMIZATION**  
**DISTRIBUTION SOLUTIONS**  
**WAREHOUSE SERVICES**  
**CONTRACT MANUFACTURING**  
**ASSET DISPOSITION**



Izzy Industries is a manufacturer and wholesale OEM. One of our core philosophies is adapting to our customers needs for a mutually beneficial relationship. From private label products to new product design, through patent and UL processes and product customization, we strive to make doing business with us a high value transaction for our customers. We believe in the value of relationships, so if there is a product or service we don't openly advertise please ask, we are more than willing to help.

**Please contact us for more information. Email: [orders@izzyindustries.com](mailto:orders@izzyindustries.com) or call 603-546-7117**

## PIM Universal Stand Off Adapters

### General Specifications

UV resistant nylon 6-6 construction

- 40° C to +70° C

IM3<-100 dBm

Use two PIM-IZ-16-250 per to attach to tower



PIM-USO-34



PIM-MINI-USO-534



PART #	DESCRIPTION	QUANTITY
PIM-USO-34	Universal Stand Off Adapters. 3 – 3/4” Hole, Nylon 6-6 Construction	Pack of 10
PIM-MINI-USO-534	Universal Stand Off adapters, 5 – 3/4” Hole, Nylon 6-6 Construction	Pack of 10

## PIM Acetal Cable Straps

### General Specifications

UV resistant nylon 6-6 construction

- 40° C to +70° C

IM3<-100 dBm

Use with PIM-USO-34 to firmly attach to tower



PART #	DESCRIPTION	QUANTITY
PIM-IZ-16-250	PIM Acetal Cable Straps, 16” Length Acetal Construction	Pack of 50
PIM-IZ-27-250	PIM Acetal Cable Straps 27” Length, Acetal construction	Pack of 25
PIM-INSERT	Patent Pending PIM insert. Use to avoid metal mismatch on tower sites	Bag of 10

## PIM Products

### General Specifications

UV resistant nylon 6-6 construction  
 - 40° C to +70° C  
 IM3<-100 dBm



PART #	DESCRIPTION	QUANTITY
ACE-ROLL	50' roll of 1/2" acetal strapping or banding`	1
ACE-TOOL	Acetal banding tool	1
ACE-BUCKLE	Acetal 1/2" banding buckle	Bag of 100

## Galvanized Angle Adaptors

### General Specifications

Galvanized Steel Construction  
 - 40° C to +70° C  
 IM3<-100 dBm



PART #	DESCRIPTION	QUANTITY
AA-34-G	3/4" Snap-In Hole, Galvanized Steel	Kit of 10
AA-38-G	3/8" Galvanized Angle Adapter with 3/8" Tapped Hole	Kit of 10

## Stackable Snap-In Hangers

### General Specifications

Heavy duty 304 Stainless Steel construction  
 Compact Solution for Supporting Coaxial Cable  
 Up to 3 Runs of Cable

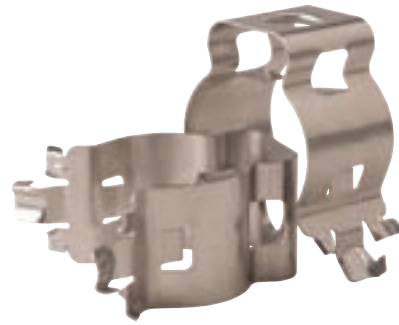

PART #	DESCRIPTION	QUANTITY
SSH-12	Stackable Snap In Hanger For 1/2" Cable	Kit of 10
SSH-78	Stackable Snap In Hanger For 7/8" Cable	Kit of 10
SSH-114	Stackable Snap In Hanger For 1 1/4" Cable	Kit of 10
SSH-158	Stackable Snap In Hanger For 1 5/8" Cable	Kit of 10
SSH-XL	Adjustable Stackable Snap In Hanger for 36mm to 51mm Cable	Kit of 10

## Snap-In Hangers

### General Specifications

Durable 304 Stainless Steel construction  
 For use on corrugated cables  
 Smooth edging to prevent accidental cuts to installers



PART #	DESCRIPTION	CABLE DIAMETER MAX.	CABLE DIAM MIN.	QUANTITY
SI-12	Snap-In Hanger 1/2"	0.640 in.	0.41 in.	Kit of 10
SI-58	Snap-In Hanger 5/8"	0.867 in.	0.820 in.	Kit of 10
SI-78	Snap-In Hanger 7/8"	1.220 in.	1.050 in.	Kit of 10
SI-114	Snap-In Hanger 1-1/4"	1.700 in.	1.480 in.	Kit of 10
SI-158	Snap-In Hanger 1-5/8"	2.050 in.	1.900 in.	Kit of 10
SI-214	Snap-In Hanger 2-1/4"	2.360 in.	2.290 in.	Kit of 10



## Butterfly Hangers

### General Specifications

Durable 304 Stainless Steel construction  
 Compatible with corrugated, smooth wall and elliptical waveguide  
 3/8" mounting hardware included  
 Captivated slotted SS screw and nut for tightening  
 Attach with banding, hose clamps, angle adapters and stand offs

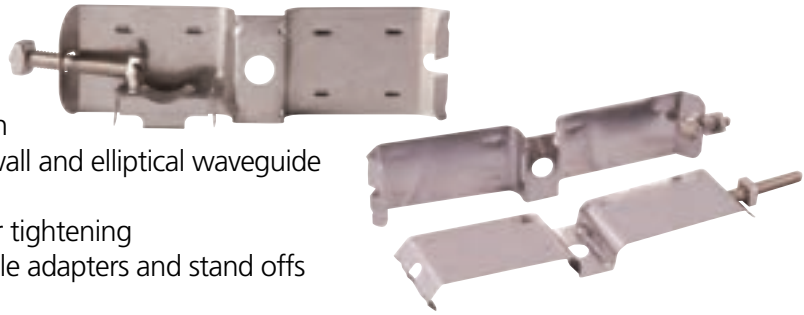

PART #	DESCRIPTION	CABLE DIAMETER MAX.	CABLE DIAM MIN.	QUANTITY
BH-12	Butterfly Hanger 1/2"	0.64 in.	0.41 in.	Kit of 10
BH-58	Butterfly Hanger 5/8"	0.867 in.	0.820 in.	Kit of 10
BH-78	Butterfly Hanger 7/8"	1.220 in.	1.050 in.	Kit of 10
BH-114	Butterfly Hanger 1-1/4"	1.700 in.	1.480 in.	Kit of 10
BH-158	Butterfly Hanger 1-5/8"	2.050 in.	1.900 in.	Kit of 10
BH-214	Butterfly Hanger 2-1/4"	2.360 in.	2.290 in.	Kit of 10

## Anchor Rail Adapters for Snap-In Hangers

### General Specifications

Durable 304 Stainless Steel construction  
 3/4" hole for use with snap in hangers



PART #	DESCRIPTION	QUANTITY
IRA22	Anchor Rail Adapter With 3/4" Hole	Kit of 10

# CABLE ATTACHMENT

## Mini Angle Adapters

### General Specifications

Heavy duty 304 Stainless Steel construction  
 3/8" tapped hole



PART #	DESCRIPTION	QUANTITY
MAA-38	SS Mini Angle Adapter With Tapped Hole	Kit of 10

## 3/8" Tapped Hole Angle Adapters

### General Specifications

Heavy duty 304 Stainless Steel construction  
 Serrated edge grabs onto and holds steel surfaces  
 1" opening  
 All Angle Adapters come with 3/8" Fillister/ Frankenstein bolt  
 Allows for various attachment points on cell-site



AA-38

AA-38-G

PART #	DESCRIPTION	QUANTITY
AA-38	3/8" Threaded Tapped Hole	Kit of 10

## Universal Angle Adapters

### General Specifications

Heavy duty 304 Stainless Steel construction  
 Serrated edge grabs onto and holds steel surfaces  
 1" opening  
 All Angle Adapters come with 3/8" Fillister/ Frankenstein bolt  
 Slotted to accept banding or hose clamps  
 Accepts up to 2 Snap-Ins



PART #	DESCRIPTION	QUANTITY
AA-U	SS Angle Adapter with 3/4" hole for Snap-In Hangers	Kit of 10
AA-UI	SS Angle Adapter with 3/4" Hole and Hardware	Kit of 10
INSERT-38	3/8" Insert with Hardware	Kit of 10

## Tower Stand Off Adapters with 3/8" Tapped Hole

### General Specifications

3/8" threaded hole

Heavy duty 304 Stainless Steel construction

Accepts hose clamps and banding

All kits stand 1" off leg

Hardware sold separately



PART #	DESCRIPTION	QUANTITY
SA-38	2"-3" Stand Off with 3/8" Tapped Hole	Kit of 10

## Universal Stand Off with 3/4" Hole For Snap-Ins

### General Specifications

3/4" hole for Snap-Ins

Heavy duty 304 Stainless Steel construction

Accepts hose clamps and banding

All kits stand 1" off leg

Hardware sold separately



PART #	DESCRIPTION	QUANTITY
SA-U	2"-3" Stand Off with 3/4" Hole. Universal	Kit of 10

# CABLE ATTACHMENT

## Universal 3-Way Stand Off Adapters

### General Specifications

Durable 304 Stainless Steel construction  
 Accepts up to 1-5/8" Snap-In hangers  
 Accepts up to 3/4" banding



PART #	DESCRIPTION	QUANTITY
USO-34	Stainless Universal Stand Off Adapters	Kit of 10

## Insert Kits

### General Specifications

3/8" threaded insert with stainless steel hardware  
 Compatible with 3/4" stand offs and angle adapters  
 Includes bolts and locks



PART #	DESCRIPTION	QUANTITY
INSERT-38	3/8" Insert With Bolt and Star Washer	10 / Pack
HK-38	3/8" Stainless Steel Bolt and Star Washer	10 / Pack

## Stainless Steel Hose Clamps

### General Specifications

Marine Grade 304 Stainless Steel hose clamps  
 Round member adapters



RM-A200

PART #	DESCRIPTION	SAE SIZES	MIN. DIAMETER	QUANTITY
RM-A100	1" - 2" Hose Clamps	24	1 in.	Kit of 10
RM-A200	2" - 3" Hose Clamps	40	2 in.	Kit of 10
RM-A350	3" - 5" Hose Clamps	72	3 in.	Kit of 10
RM-A500	5" - 6" Hose Clamps	88	5 in.	Kit of 10
RM-A210	2" - 10" Hose Clamps	N/A	2 in.	Kit of 10
RM-A1012	10" to 12" Hose Clamps	N/A	10 in.	Kit of 10
MAKEACLAMP	100' of hose clamp banding, 25 adjustable fasteners and 10 band splices, SS 316			Kit of 1

## Clamp Heads

### General Specifications

Durable 304 Stainless Steel construction  
 Accepts 1/2" banding or hose clamps  
 3/8" hole for common hardware mounting



PART #	DESCRIPTION	QUANTITY
CH-10	Stainless Steel Clamp Heads	Kit of 10

## Coax Support Blocks

### General Specifications

Durable UV resistant polypropylene material  
 Interior rib construction offers better cable retention  
 3/8" hole accommodates common hardware



PART #	DESCRIPTION	QUANTITY
CB-14	1/4" Coax Block Assemblies	Kit of 10
CB-38	3/8" Coax Block Assemblies	Kit of 10
CB-12	1/2" Coax Block Assemblies	Kit of 10
CB-78	7/8" Coax Block Assemblies	Kit of 10
CB-114	1-1/4" Coax Block Assemblies	Kit of 10
CB-158	1-5/8" Coax Block Assemblies	Kit of 10
CB-214	2-1/4" Coax Block Assemblies	Kit of 10

## Coax Block Hardware Kits

### General Specifications

Available in both galvanized and stainless steel  
 Each Kit contains 30 flat washers, 30 lock washers,  
 30 hex nuts, 10 pieces of 3/8" threaded rod



Part Number	Single Stack	Double Stack	Triple Stack	Rod Length	Material Type
CBHK-SS-6	1-1/4" or 1-5/8"	1/4" to 7/8"	1/2" and smaller	6"	Stainless Steel
CBHK-SS-8	-	1-1/4"	7/8"	8"	Stainless Steel
CBHK-SS-10	-	-	1-5/8"	10"	Stainless Steel
CBHK-SS-12	-	-	1-5/8"	12"	Stainless Steel
CBHK-GS-6	1-1/4" or 1-5/8"	1/4" to 7/8"	1/2" and smaller	6"	Galvanized Steel
CBHK-GS-8	-	1-1/4"	7/8"	8"	Galvanized Steel
CBHK-GS-10	-	-	1-5/8"	10"	Galvanized Steel

## PVC Sleepers

General Specifications  
 Roof Top Attachment option  
 Heavy Duty PVC construction



PART #	DESCRIPTION	QUANTITY
PVCRS-4	PVC Roof Sleeper - 4 runs	1
PVCRS-8	PVC Roof Sleeper - 8 runs	1
PVCRS-B96	PVC Roof Sleeper - Blank-8' long	1

## Threaded Rod Safety Caps

General Specifications  
 Vinyl safety caps for threaded rod



VSC-38



VSC-RL-38

PART #	DESCRIPTION	QUANTITY
VSC-38	3/8" Vinyl Cap for Threaded Rod, 1/2" Long (Black)	Kit of 100
VSC-RL-38	3/8" Vinyl Cap for Threaded Rod, 1" Long (Red)	Kit of 100
VSC-12-R	1/2" Vinyl Cap for Threaded Rod, 1" Long (Red)	Kit of 100
VSC-58-R	5/8" Vinyl Cap for Threaded Rod, 1" Long (Red)	Kit of 100

## Stringer End Caps

General Specifications  
 PVC construction  
 UV resistant

PART #	DESCRIPTION	QUANTITY
SEC-BL	Black Stringer End Cap for 1.5" stringer	Bag of 100

## Universal Barrel Cushions

### General Specifications

Durable UV resistant

Universal design for greater flexibility of use

For Fiber, Power, Elliptical and Coaxial Cable



PART #	DESCRIPTION	CABLE RANGE	QUANTITY
UBC-12	1/2" Hanger or Block	3mm to 13mm	Kit of 10
UBC-78	7/8" Hanger or Block Size	4mm to 14mm	Kit of 10
UBC-114	1-1/4" Hanger or Block Size	14mm to 25mm	Kit of 10
UBC-158	1-5/8" Hanger or Block Size	14mm to 36mm	Kit of 10
UBC-214	2 1/4" Hanger or Block Size	14mm to 45mm	Kit of 10
UBC-158-MH	Multi-Hole Universal Barrel Cushion for 7	4mm to 10mm holes for 1-5/8"	Kit of 10

## Hanger Adapters

### General Specifications

For use with Snap-Ins and coax blocks

Accepts various cable and wire sizes



SSHA-158-28-HD

SSHA-14

SSH-38

SSHA-158-U

PART #	DESCRIPTION	QUANTITY
SSHA-14	1/2" Insert For LMR 240 And Fiber Jumpers	Kit of 10
SSHA-38	1/2" Adapter For Use With 3/8" Cable	Kit of 10
SSHA-78-7	7/8" Adapter For Use With 7mm-11mm Cable	Kit of 10
SSHA-78-11	7/8" Adapter For Use With 11mm-17mm Cable	Kit of 10
SSHA-114-7	1-1/4" Adapter For Use With 7mm-11mm Cable	Kit of 10
SSHA-114-11	1-1/4" Adapter For Use With 11mm-17mm Cable	Kit of 10
SSHA-114-17	1-1/4" Adapter For Use With 17mm-20mm Cable	Kit of 10
SSHA-158-1-39.5	1-5/8" heavy duty insert with 39.5mm to 40mm hole	Kit of 10
SSHA-158-1-10-1-20	1-5/8" insert with 1 10mm hole and 1 20mm hole	Kit of 10
SSHA-158-4-6-2-16	1-5/8" insert with 4 6mm hole and 2 16mm hole	Kit of 10
SSHA-158-10-3-28-1	1-5/8" heavy duty insert with 3 10mm holes and 1 28mm holes	Kit of 10
SSHA-158-24-1-10-1	1-5/8" heavy duty insert with 1 24.3 mm hole and 1 10mm hole	Kit of 10
SSHA-158-12-4	1-5/8" heavy duty insert with 4 1/2" holes	Kit of 10
SSHA-158-28-HD	1-5/8" Heavy Duty Insert for 28mm to 40mm	Kit of 10
SSHA-214-224110	2-1/4" Insert for Two 24.3mm Cables and One 10mm Cable	Kit of 10



## Pre-Laced Hoisting Grips

General Specifications  
 Durable Stainless Steel construction  
 Oetiker Clamp included



1/4" Grip Shown

PART #	DESCRIPTION	QUANTITY
HG-PL-14	1/4" Pre-Laced Hoisting Grip	1
HG-PL-38	3/8" Pre-Laced Hoisting Grip	1
HG-PL-12	1/2" Pre-Laced Hoisting Grip	1
HG-PL-58	5/8" Pre-Laced Hoisting Grip	1
HG-PL-78	7/8" Pre-Laced Hoisting Grip	1
HG-PL-114	1-1/4" Pre-Laced Hoisting Grip	1
HG-PL-158	1-5/8" Pre-Laced Hoisting Grip	1
HG-PL-214	2-1/4" Pre-Laced Hoisting Grip	1

## Lace Up Hoisting Grips

General Specifications  
 Durable Stainless Steel construction



1/4" Grip Shown

PART #	DESCRIPTION	QUANTITY
HG-14	1/4" Lace Up Hoisting Grip	1
HG-38	3/8" Lace Up Hoisting Grip	1
HG-12	1/2" Lace Up Hoisting Grip	1
HG-58	5/8" Lace Up Hoisting Grip	1
HG-78	7/8" Lace Up Hoisting Grip	1
HG-114	1-1/4" Lace Up Hoisting Grip	1
HG-158	1-5/8" Lace Up Hoisting Grip	1
HG-214	2-1/4" Lace Up Hoisting Grip	1

# CABLE ATTACHMENT

## Stainless Steel Banding

### General Specifications

Packaged in easy to use carrying case

Superior construction



PART #	DESCRIPTION	QUANTITY
SSB-12	1/2" x .03" x 100' Roll	100' Roll
SSB-34	3/4" x .03" x 100' Roll	100' Roll

## Ear Lock Buckles

### General Specifications

Heavy duty stainless steel construction



PART #	DESCRIPTION	QUANTITY
BB-12	1/2" Ear Lock Buckles	100 / Box
BB-34	3/4" Ear Lock Buckles	100 / Box

## Banding Tightening Tool

### General Specifications

Superior construction

Stainless steel and cast iron construction



PART #	DESCRIPTION	QUANTITY
SSB-TOOL	Banding Tightening Tool	1

## 304 Stainless Steel Zip Ties

### General Specifications

Durable 304 Stainless Steel Finish  
 Low profile, self locking, ball bearing head mechanism with fully adjustable strap provides quick installation  
 Fully enclosed head does not allow dirt or grit to interfere with locking mechanism  
 High tensile strength adds strength and safety on heavy duty applications  
 Smooth round edges ensure safe, efficient handling



PART #	DESCRIPTION	QUANTITY
ZT-S-14	350mm x 4.6mm x .25mm (14" x 3/16") Zip Ties	100 / bag

## Nylon Zip Ties

### General Specifications

UL listed  
 Self locking nylon cable ties  
 UV resistant  
 Plenum rated  
 Sold in 50lb., 120lb., or 250lb. test



PART #	DESCRIPTION	QUANTITY
IZ-7-50	7" Long, 50 lb. Test	100 / Bag
IZ-11-50	11" Long, 50 lb. Test	100 / Bag
IZ-14-50	14" Long, 50 lb. Test	100 / Bag
IZ-17-50	17" Long, 50 lb. Test	100 / Bag
IZ-14-120	14" Long, 120 lb. Test	100 / Bag
IZ-18-120	18" Long, 120 lb. Test	100 / Bag
IZ-24-250	24" Long, 250 lb. Test	100 / Bag

## Hook and Loop Cable Tie Wraps

### General Specifications

Easy installation

Hook and cinch design

May be readjusted and reused

Compare to Velcro™ brand



PART #	DESCRIPTION	QUANTITY
VEL-050x8-BLACK	1/2" x 8" Cable Tie Wrap	100/Pack
VEL-050x12-BLACK	1/2" x 12" Cable Tie Wrap	100/Pack
VEL-075x8-BLACK	3/4" x 8" Cable Tie Wrap	100/Pack
VEL-075x12-BLACK	3/4" x 12" Cable Tie Wrap	100/Pack

## Hook and Loop Rolls

### General Specifications

Easy cable management

Reduces waste by cutting to length

Compare to Velcro™ brand



PART #	DESCRIPTION	QUANTITY
VEL-050x75-BLACK	1/2" x 75' Roll of Hook and Loop Black	1 Roll
VEL-075x75-BLACK	3/4" x 75' Roll of Hook and Loop Black	1 Roll
VEL-050x75-BROWN	1/2" x 75' Roll of Hook and Loop Brown	1 Roll
VEL-050x75-RED	1/2" x 75' Roll of Hook and Loop Red	1 Roll

## Stainless Steel Hardware

### General Specifications

Durable 304 Stainless Steel construction



PART #	DESCRIPTION	QUANTITY
BOLT38X114SS	3/8" x 1 1/4" Hex Head Bolts	Kit of 100



PART #	DESCRIPTION	QUANTITY
HEXNUT38SS	3/8" -16 Hex Nut	Kit of 100

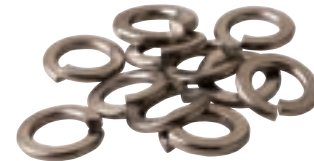

PART #	DESCRIPTION	QUANTITY
LOCKWASH38SS	3/8" Lock Washer	Kit of 100



PART #	DESCRIPTION	QUANTITY
FLATWASH38SS-78	3/8" Flat Washer-7/8"OD	Kit of 100
FLATWASH38SS-58	3/8" Flat Washer-5/8"OD	Kit of 100

# CABLE ATTACHMENT

## Lug Washer

### General Specifications

1.75" x 0.75"

1" OC Design

No overlap on bus bars

Saves times and materials

Easy Installation



PART #	DESCRIPTION	QUANTITY
LUG-WASH	SS Double Lug Washer for 3/8" Hardware	100 / Pack

## Mini Hardware Kit

### General Specifications

3/8" bolt and star washer



PART #	DESCRIPTION	QUANTITY
HK-38	3/8" Stainless Steel Bolt and Star Washer	10 / Pack
HK-38x114SS-10	3/8" - 1-1/4" bolt, lock, 5/8" OD flat and hex nut SS304	10 / Pack

## Fiber Tags for Cable Identification

**General Specifications**  
Simple install. Durable nylon  
Easy identification system  
UL recognized material



PART #	DESCRIPTION	QUANTITY
FTAG-1.75	Fiber Tag 1.75" x 1.0"	Kit of 100
FTAG-1.75-W	Fiber Tag 1.75" x 1.0" White	Kit of 100

## Rubber Cushion Steel Cable Clamps

**General Specifications**  
Use for securing and routing wire, cable, tubing and hoses  
Ideal for securing in rugged applications  
Protects against shocks and vibrations



PART #	DESCRIPTION	QUANTITY
CC-12-14	Rubber Cushion Steel Cable Clamp, 1/2" Holding Diameter, 1/4" Stud Size	Bag of 100
CC-38-14	Rubber Cushion Steel Cable Clamp, 3/8" Holding Diameter, 1/4" Stud Size	Bag of 100
CC-14-14	Rubber Cushion Steel Cable Clamp, 1/4" Holding Diameter, 1/4" Stud Size	Bag of 100

## RET AISG 2.0 Male to Female Assemblies

### General Specifications

AISG Compatible v 1.1 & v 2.0

Up to 300 V max.

Standard length (m) from 0.5 to 200

Terminated AISG 8 pin socket screw lock male and female

Temperature range: -15° C to +70° C, Humidity up to 100%

IP Rating: IP67



PART #	DESCRIPTION
IRETC-0.5	0.5 meter RET AISG 2.0 Cable Assembly
IRETC-1.0	1 meter RET AISG 2.0 Cable Assembly
IRETC-2.0	2 meter RET AISG 2.0 Cable Assembly
IRETC-3.0	3 meter RET AISG 2.0 Cable Assembly
IRETC-4.0	4 meter RET AISG 2.0 Cable Assembly
IRETC-5.0	5 meter RET AISG 2.0 Cable Assembly
IRETC-6.0	6 meter RET AISG 2.0 Cable Assembly
IRETC-7.0	7 meter RET AISG 2.0 Cable Assembly
IRETC-8.0	8 meter RET AISG 2.0 Cable Assembly
IRETC-9.0	9 meter RET AISG 2.0 Cable Assembly
IRETC-10	10 meter RET AISG 2.0 Cable Assembly
IRETC-15	15 meter RET AISG 2.0 Cable Assembly
IRETC-20	20 meter RET AISG 2.0 Cable Assembly
IRETC-25	25meter RET AISG 2.0 Cable Assembly
IRETC-30	30meter RET AISG 2.0 Cable Assembly
IRETC-40	40 meter RET AISG 2.0 Cable Assembly
IRETC-50	50 meter RET AISG 2.0 Cable Assembly
IRETC-60	60 meter RET AISG 2.0 Cable Assembly
IRETC-70	70 meter RET AISG 2.0 Cable Assembly
IRETC-80	80 meter RET AISG 2.0 Cable Assembly
IRETC-90	90 meter RET AISG 2.0 Cable Assembly
IRETC-100	100 meter RET AISG 2.0 Cable Assembly
IRETC-200	200 meter RET AISG 2.0 Cable Assembly



## Dummy Loads

### General Specifications

IP65 rated

50 Ohm

Temperature rated -35°C ±125°C

DC-3GHz frequency range



DM-2W-D



NM-2W-D



DM-2W-TRI

PART #	DESCRIPTION	QUANTITY
4.3M-2W-D	4.3-10 2 Watt Dummy Load 3GHz	1
DM-2W-D	Din Male 2 Watt Dummy Load 3GHz	1
NM-2W-D	N Male 2 Watt Dummy Load 3GHz	1
DM-2W-TRI	Din Male 2 Watt Dummy Load 3 Ghz Tri Metal Body	1



DM-5W-D



NM-5W-D



4.3DM-5W-D

PART #	DESCRIPTION	QUANTITY
DM-5W-D	Din Male 5 Watt Dummy Load 3 GHz	1
NM-5W-D	N Male 5 Watt Dummy Load 3 GHz	1
4.3M-5W-D	4.3-10 5 Watt Dummy Load 3GHz	1



DM-10W-D

PART #	DESCRIPTION	QUANTITY
DM-10W-D	Din Male 10 Watt Dummy Load 3 GHz	1
NM-10W-D	N Male 10 Watt Dummy Load 3 GHz	1
4.3M-10W-D	4.3-10 10 Watt Dummy Load 3GHz	1

PART #	DESCRIPTION	QUANTITY
DM-25W-D	Din Male 25 Watt Dummy Load 3 Ghz	1
NM-25W-D	N Male 25 Watt Dummy Load 3 Ghz	1
4.3M-25W-D	4.3-10 Male 25 Watt Dummy Load 3 Ghz	1



DM-25W-D



NM-25W-D

PART #	DESCRIPTION	QUANTITY
DM-50W-D	Din Male 50 Watt Dummy Load 3 Ghz	1
NM-50W-D	N Male 50 Watt Dummy Load 3 Ghz	1
4.3M-50W-D	4.3-10 Male 50 Watt Dummy Load 3 Ghz	1



DM-50W-D



NM-50W-D

PART #	DESCRIPTION	QUANTITY
DM-75W-D	Din Male 75 Watt Dummy Load 3 Ghz	1
NM-75W-D	N Male 75 Watt Dummy Load 3 Ghz	1
4.3M-75W-D	4.3-10 Male 75 Watt Dummy Load 3 Ghz	1
4.3F-100W-D	4.3-10 Female 100 Watt Dummy Load 3 Ghz	1



DM-75W-D

PART #	DESCRIPTION	QUANTITY
DM-100W-D	Din Male 100 Watt Dummy Load 3 Ghz	1
NM-100W-D	N Male 100 Watt Dummy Load 3 Ghz	1
NF-100W-D	N Female 100 Watt Dummy Load 3 Ghz	1
4.3M-100W-D	4.3-10 Male 100 Watt Dummy Load 3 Ghz	1



DM-100W-D



## Low PIM Test Termination Loads

### General Specifications

Low Pim RF coaxial load for transmitter, termination and testing

Extremely low VSWR

PART #	DESCRIPTION	QUANTITY
DM-50W-LP	Low Pim Din Male 50W Dummy Load 3Ghz	1
DF-50W-LP	Low Pim Din Female 50W Dummy Load 3 Ghz	1
DF-100W-LP	Low Pim Din Female 100 Dummy Load 3 Ghz	1
NM-50W-LP	Low Pim N Male 50W Dummy Load 3 Ghz	1
NF-50W-LP	Low Pim N Female 50W Dummy Load 3 Ghz	1
NF-100W-LP	Low Pim N Female 100W Dummy Load 3 Ghz	1
4.3M-50W-LP	Low Pim 4.3-10 Male 50W Dummy Load 3 Ghz	1
4.3F-50W-LP	Low Pim 4.3-10 Female 50W Dummy Load 3 Ghz	1
4.3F-100W-LP	Low Pim 4.3-10 Female 100W Dummy Load 3 Ghz	1
4.3M-150W-LP	Low Pim 4.3-10 Male 150W Dummy Load 3 Ghz	1
DM-75W-LP	Low Pim Din Male 75W Dummy Load 3 Ghz	1
DM-100W-LP	Low Pim Din Male 100 Watt Dummy Load 3 Ghz	1

## Nex10 Termination Loads

PART #	DESCRIPTION	QUANTITY
2W-NEX10M-D	2W Nex10 Male Termination load DC-6GHz	1
5W-NEX10M-D	5 Watt Nex10 Male Termination load DC-6GHz	1
10W-NEX10M-D	10W Nex10 Male Termination load DC-6GHz	1
25W-NEX10M-D	25W Nex10 Male Termination load DC-6GHz	1
50W-NEX10M-D	50W Nex10 Male Termination load DC-6GHz	1

## Low PIM Coaxial Adapters

### General Specifications

Low PIM and Low VSWR

Tri-metal plating

PART #	DESCRIPTION	QUANTITY
NF-DM	N Female to Din Male	1
DF-DF	Din Female to Din Female	1
NM-NM	N Male to N Male	1



PART #	DESCRIPTION	QUANTITY
NF-NF	N Female to N Female	1
DM-NM	Din Male to N Male	1
NM-DF	N Male to Din Female	1



PART #	DESCRIPTION	QUANTITY
NF-DF	N Female to Din Female	1
DM-DM	Din Male to Din Male	1
DM-DF	Din Male to Din Female	1



PART #	DESCRIPTION	QUANTITY
MDM-NM	4.1/9.5 Mini Din Male to N Male	1
MDM-NF	4.1/9.5 Mini Din Male to N Female	1
MDF-NM	4.1/9.5 Mini Din Female to N Male	1



PART #	DESCRIPTION	QUANTITY
MDF-NF	4.1/9.5 Mini Din Female to N Female	1
MDM-DM	4.1/9.5 Mini Din Male to 7/16" Din Male	1
MDM-DF	4.1/9.5 Mini Din Male to 7/16" Din Female	1



PART #	DESCRIPTION	QUANTITY
NEX10M-4.3M	NEX10 Male to 4.3-10 male low pim adapter	1
NEX10M-4.3F	NEX10 Male to 4.3-10 female low pim adapter	1
NEX10F-4.3M	NEX10 female to 4.3-10 Male low pim adapter	1
NEX10F-4.3F	NEX10 female to 4.3-10 female low pim adapter	1



MDF-DM



MDF-DF



4.3MDF-DM



4.3MDM-DF

PART #	DESCRIPTION	QUANTITY
MDF-DM	4.1/9.5 Mini Din Female to 7/16" Din Male	1
MDF-DF	4.1/9.5 Mini Din Female to 7/16" Din Female	1
4.3F-DF	4.3-10- Female to 7/16 Din Female	1
4.3MDF-DM	4.3/10 Female to 7/16" Din Male	1
4.3MDM-DF	4.3/10 Male to 7/16" Din Female	1
4.3M-NF	4.3 Male to N Female	1
4.3M-4.3M	4.3 Male to 4.3 Male	1
4.3F-NF	4.3 Female to N Female	1
4.3F-NM	4.3 Female to N Male Adapter	1
4.3F-4.3F	4.3 Female to 4.3 Female Adapter	1
4.3M-DM	4.3 Male to Din Male adapter	1
4.3M-4.3F	4.3 Male to 4.3 Female adapter	1
4.3M-NM	4.3 Male to N male adapter	1
QM-SF	QMA Male to SMA Female low pim adapter	1
QM-NF	QMA Male to N Female low pim adapter	1
QM-NM	QMA Male to N Male low pim adapter	1
SF-SF	SMA Female to SMA Female low pim adapter	1
SM-SM	SMA Male to SMA Male	1
SF-NF	SMA Female to N Female low pim adapter	1
SM-NF	SMA Male to N Female low pim adapter	1
SM-NM	SMA Male to N Male low pim adapter	1
SF-NM	SMA Female to N Male low pim adapter	1

## Fiber Cleaning Accessories

### General Specifications

Available in push type and reel type cleaners



CLEBOX-CART



CLEBOX

PART #	DESCRIPTION	QUANTITY
CLEBOX	Compact Cleaning Box Type A with White Tape	1
CLEBOX-CART	Replacement Cartridge for CLEBOX Type White Tape	1
MPO-CLEANPEN	Cleaning Pen for SM/MM MPO/MTP Connectors 600 Cleans	1
ONECLICK-125MM	One Click Cleaning Pen 1.25mm LC/MU 800 Cleans	1
ONECLICK-250MM	One Click Cleaning Pen 2.5mm SC/ST/FC 800 Cleans	1



MPO-CLEANPEN



ONECLICK-125MM



ONECLICK-250MM

## Boot Assemblies

### General Specifications

Material unaffected by ozone, sunlight or aging

EPDM rubber

Includes two 304 stainless steel hose clamps

One piece design for easy installation

Inserts and plugs sold separately



BA-XX

PART #	DESCRIPTION	QUANTITY
BA-XX	4" Boot Without Insert	1
BA-5X	5" Boot Without Insert	1



BA-5X

## 4" Cushion Inserts

### General Specifications

Designed for use in entry port boots  
 Durable EPDM rubber design and construction  
 Works with both 4" and 5" boots



CI-1-38



CI-3-38

PART #	DESCRIPTION	QUANTITY
CI-1-38	1 Hole for 3/8"	1
CI-2-38	2 Hole for 3/8"	1
CI-3-38	3 Hole for 3/8"	1
CI-4-38	4 Hole for 3/8"	1
CI-5-38	5 Hole for 3/8"	1



CI-1-12



CI-2-12



CI-3-12



CI-9-12

CI-1-12	1 Hole for 1/2"	1
CI-2-12	2 Hole for 1/2"	1
CI-3-12	3 Hole for 1/2"	1
CI-4-12	4 Hole for 1/2"	1
CI-9-12	9 Hole for 1/2"	1
CI-1-58	1 Hole for 5/8"	1
CI-2-58	2 Hole for 5/8"	1
CI-3-58	3 Hole for 5/8"	1
CI-4-58	4 Hole for 5/8"	1



CI-1-78



CI-2-78



CI-3-78



CI-4-78

CI-1-78	1 Hole for 7/8"	1
CI-2-78	2 Hole for 7/8"	1
CI-3-78	3 Hole for 7/8"	1
CI-4-78	4 Hole for 7/8"	1



## 4" Cushion Inserts



PART #	DESCRIPTION	QUANTITY
CI-1-114	1 Hole for 1-1/4"	1
CI-1-158	1 Hole for 1-5/8"	1
CI-1-214	1 Hole for 2-1/4"	1
CI-B	Solid Insert. No Hole	1
CI-12-2-PC1	3 Hole 2x18mm and 1x10mm with Plugs	1
CI-2-78-1-38	3 Hole with two 7/8" Holes and 1 - 3/8" Hole	1
CI-1-20-1-10	1 20mm and 1 - 10mm Holes	1
CI-3-24.5-1-10	1 24.5mm Holes and 1 - 10mm Hole	1
CI-4-20-2-10	4 x 20mm Holes and 2 - 10mm Holes	1
CI-4-20-3-10	4 - 20mm holes and 3 - 10mm Holes	1
CI-1-EW63	1 Hole for EW63 Elliptical Cable	1
CI-2-EW63	2 Hole for EW63 Elliptical Cable	1
CI-1-EW52	1 Hole for EW52 Elliptical Cable	1
CI-1-EW90	1 Hole for EW90 Elliptical Cable	1

## Cushion Plug

### General Specifications

Used to seal unused holes



PART #	DESCRIPTION	QUANTITY
PLUG-38	3/8" Insert Plug	Kit of 5
PLUG-12	1/2" Insert Plug	Kit of 5
PLUG 78	7/8" Insert Plug	Kit of 5
PLUG-114	1-1/4" Insert Plug	Kit of 5
PLUG-158	1-5/8" Insert Plug	Kit of 5

## Entry Port Panels

### General Specifications

Heavy duty aluminum construction

Powder coat finish

Sealing caps and mounting hardware included



EPP-1x1B

PART #	DESCRIPTION	SIZE	QUANTITY
EPP-1x1A	1 Port Panel	5" x 5"	10 / Case
EPP-1x1B	1 Port Panel	7" x 7"	10 / Case
EPP-1x2	2 Port Panel	1' 3-1/2" x 9-1/2"	10 / Case
EPP-1x3	3 Port Panel	1' 8" x 9-1/2"	10 / Case
EPP-1x4	4 Port Panel	2' 1-1/2" x 9-1/2"	10 / Case
EPP-1x6	6 Port Panel	3' 1/2" x 9-1/2"	5 / Case
EPP-2*2A	4 Port Panel	11" x 11"	10 / Case
EPP-2x2B	4 Port Panel	1' 5-1/2" x 1' 5-1/2"	10 / Case
EPP-2x3	6 Port Panel	1' 11" x 1' 5-1/2"	10 / Case
EPP-2x4	8 Port Panel	2' 1-1/2" x 1' 5-1/2"	5 / Case
EPP-2x6	12 Port Panel	3' 3-1/2" x 1' 5-1/2"	5 / Case
EPP-3x3	9 Port Panel	1' 11" x 1' 11"	5 / Case
EPP-3x4	12 Port Panel	2' 1-1/2" x 2' 1-1/2"	5 / Case
EPP-4x4	16 Port Panel	2' 1-1/2" x 2' 1-1/2"	5 / Case
EPP-4x6	24 Port Panel	3' 2-1/2" x 2' 7"	5 / Case
EPP-CAP	Entry Port Panel Cap	4" ID	1



EPP-1x4



EPP-CAP

## Universal Weatherproofing Kit

### General Specifications

All-weather weatherproofing kit

Ideal for sealing connections

UL Listed electrical PVC tape



PART #	DESCRIPTION	QUANTITY
WK-U	Contents:	1 Kit
	- 6 Rolls Butyl Mastic (2-1/2" x 2')	
	- 2 Rolls Electrical PVC Tape (3/4" x 66')	
	- 1 Roll Wide Electrical PVC Tape (2" x 20')	

## Butyl Rubber And Electrical PVC Tape

### General Specifications

Butyl provides additional moisture seal for cable connections

UL Listed electrical PVC tape



BUTYL

PART #	DESCRIPTION	QUANTITY
BUTYL	2.5" x 24" Roll	200 / Case
TAPE-2	2" x 20" Wide UL Listed Electrical PVC Tape	100/Case
CTB-15	Self Fusing Magic Tape 1.5" x 15' Long Black	100 / Case
TAPE-34	3/4" x 66' Black UL Listed Electrical Tape	100 / Case
SIL-15	Rapid Wrap Silicon tape 1.5" x 15'	1



TAPE-2



CTB-15



TAPE-34

## Weatherproofing Enclosure

### General Specifications

- Alternative weatherproofing device
- Polypropylene hard case
- Clean removal
- Gel seal keeps water out
- Single use application
- High density port design
- IP67 Rated



EN-12-ANT

EN-MDMD

PART #	DESCRIPTION	QUANTITY
EN-12-ANT	1/2" To Antenna Gel Seal Enclosure	1
EN-MDMD	Slimline Enclosure 4.3-10 to Antenna	1
EN-NM-ANT	N Male to Antenna Gel Seal Enclosure	1
EN-NEX10-ANT	Nex10 Connector Enclosure to Antenna	1



EN-NM-ANT

## Silicone Cold Shrink Kit

**General Specifications**  
 Weatherproofing device  
 Silicone rubber construction  
 No tools required  
 Individually packaged  
 IP67 Rated



PART #	DESCRIPTION	QUANTITY
SCS-1278	6" long 2" Wide for 1/2" to 7/8" Connections, 2.1" ID	1
SCS-125	5" long, 47/12 mm Series for 1/2" to 1-1/2" Connection, 1.8" ID (SDL-1A-125™ equivalent)	1
SCS-3878	6" Long for 3/8" to 7/8" Connection, RRU and Power Connections 1.35" ID (SDL-DC-152™ equivalent)	1
SCS-1412	8" Long for 1/4" to 1/2" Connection, Power and Grounding Solution 3/4" OD (SDL-DC-1412™ equivalent)	1

## Din Female Cap Kits

**General Specifications**  
 Corrosion Resistant  
 IP67 Rated  
 Temperature Rated: -40°C± 85°C



DF-CK

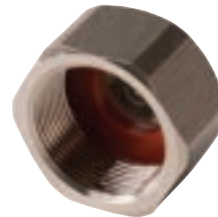

MINI-DF-CK



N10F-CK

PART #	DESCRIPTION	QUANTITY
DF-CK	Din Female Cap Kit, Brass Cap	100 / Case
MINI-DF-CK	Mini Din Female Cap Kit, Brass Cap (works on both 4.1-9.5 and 4.3-10)	100 / Case
N10F-CK	Nex10 Female Cap Kit, Brass Cap	100 / Case

## Heat Shrink Rolls

### General Specifications

- Crosslinked polyolefin
- UV Resistant
- Flame retardant
- Operating temp: -55°C to +135°C
- Minimum shrink temp: 70°C
- Minimum full recovery temp: 100°C
- Shrink ratio 2:1
- RoHS compliant
- Meets SAE-AMS-DTL-23053/5 Class 1 3
- No adhesive
- 100' spools



HS-5-BLK-SP

HS-5-CLR-SP

PART #	DESCRIPTION	COLOR	RATIO	QUANTITY
HS-.25-BLK-SP	.25" x 100' Spool. Thin Wall.	Black	2:1	10 / Case
HS-.25-CLR-SP	.25" x 100' Spool. Thin Wall.	Clear	2:1	10 / Case
HS-.375-BLK-SP	3/8" x 100' Spool. Thin Wall	Black	2:1	10 / Case
HS-.375-CLR-SP	3/8" x 100' Spool. Thin Wall	Clear	2:1	10 / Case
HS-.5-BLK-SP	.50" x 100' Spool. Think Wall.	Black	2:1	10 / Case
HS-.5-CLR-SP	.50" x 100' Spool. Thin Wall.	Clear	2:1	10 / Case
HS-.75-CLR-SP	.75" x 100' spool Thin Wall.	Clear	2:1	10 / Case
HS-.75-BLK-SP	.75" x 100' spool Thin Wall.	Black	2:1	10 / Case
HS-1.0-BLK-SP	1.0" x 100' Spool. Thin Wall.	Black	2:1	7 / Case
HS-1.0-CLR-SP	1.0" x 100' Spool. Thin Wall	Clear	2:1	7 / Case

## Izzy Heat Shrink

### General Specifications

UV Resistant, flame retardant  
 Operating temp: -55°C to +125°C  
 Minimum shrink temp: 70°C. Minimum full recovery temp: 110°C  
 Shrink ratio 3:1  
 RoHS compliant  
 Meets SAE-AMS-DTL-23053/5 Class 1 3  
 Cross linked adhesive lined polyolefin  
 Excellent sealing and insulation properties  
 4' long adhesive lined sticks  
 Sold by the case



PART #	DESCRIPTION	COLOR	QUANTITY
HS-.25X48	.25" x 48" with Adhesive, UL Listed	Black	100 / Case
HS-.375x48LD-BLUE	.375" x 48" Light Duty with Adhesive	Blue	100 / Case
HS-.50X48	.50" x 48" with Adhesive, UL Listed	Black	100 / Case
HS-.75X48	.75" x 48" with Adhesive, UL Listed	Black	100 / Case
HS-1.5X48	1.50" x 48" with Adhesive, UL Listed	Black	20 / Case

## Heavy-Duty Marine Grade Heat Shrink



HS-1.5x48HD	1.50" x 48" Heavy Duty with Adhesive	Black	20 / Case
-------------	--------------------------------------	-------	-----------

## Clear Heat Shrink



HS-.25X48-C	.25" x 48" with Adhesive	Clear	100 / Case
HS-.50X48-C	.50" x 48" with Adhesive	Clear	100 / Case
HS-.75X48-C	.75" x 48" with Adhesive	Clear	100 / Case
HS-1.5X48-C	1.50" x 48" with Adhesive	Clear	20 / Case

## Tinned Snap In Ground Kit

### General Specifications

Tinned construction for multiple cable types  
 Easy installation, wrap, snap in and weatherproof  
 Kit includes unattached lug, hardware, butyl and electrical tape



TGK-158

PART #	DESCRIPTION	QUANTITY
TGK-12	1/2" Tinned Ground Kit. 5' Attached Lead (Hardware Included)	20 / Case
TGK-78	7/8" Tinned Ground Kit. 5' Attached Lead (Hardware Included)	20 / Case
TGK-114	1-1/4" Tinned Ground Kit. 5' Attached Lead (Hardware Included)	20 / Case
TGK-158	1-5/8" Tinned Ground Kit. 5' Attached Lead (Hardware Included)	20 / Case

## Universal Tinned Ground Kit

### General Specifications

Allows for use on coax, fiber or trunk line applications  
 Markings allow for easy installation  
 Kit includes: unattached lug, hardware, butyl and electrical tape



UGK-A

PART #	DESCRIPTION	QUANTITY
UGK-A	1/2" - 3" Universal Tinned Ground Kit. 5' Attached Lead (Hardware Included)	20 / Case
MINI-UGK-A	Universal 1/4" to 5/8" Ground Kit With 5' Lead (Hardware Included)	50 / Case



MINI-UGK-A (Patent #D823256)



## Galvanized U-Bolt Assemblies

### General Specifications

Hot Dip Galvanized

Used to attach pipes to a variety of structures

Flat washers, lock washers and hex nuts included



PART #	DESCRIPTION	QUANTITY
GUB-3244	3/8" x 2-1/2" x 4" Galvanized U-Bolt Assembly	80 / Box
GUB-3355	3/8" x 3-5/8" x 5-1/4" Galvanized U-Bolt Assembly	60 / Box
GUB-4240	1/2" x 2-1/2" x 4" Galvanized U-Bolt Assembly	40 / Box
GUB-4352	1/2" x 3" x 5-1/4" Galvanized U-Bolt Assembly	40 / Box
GUB-4355	1/2" x 3-5/8" x 5" Galvanized U-Bolt Assembly	40 / Box
GUB-4356	1/2" x 3-5/8" x 6" Galvanized U-Bolt Assembly	25 / Box
GUB-4456	1/2" x 4-5/8" x 6" Galvanized U-Bolt Assembly	25 / Box
GUB-5355	5/8" x 3-5/8" x 5-1/2" Galvanized U-Bolt Assembly	20 / Box
GUB-5456	5/8" x 4-5/8" x 6-1/2" Galvanized U-Bolt Assembly	20 / Box
GUB-5245	Galvanized U bolt assembly 5/8" x 2-9/16" x 4-1/2" x 2-1/2"	1 Per
GUB-5315	Galvanized U bolt assembly 5/8" x 3-1/16" x 5" x 2-1/2"	1 Per
GUB-53555	Galvanized U bolt assembly 5/8" x 3-9/16" x 5-1/2" x 2-1/2"	1 Per
GUB-2-SS4	Stainless Steel U bolt assembly for 2" pipe	1 Per

## Galvanized J Bolt Assemblies

### General Specifications

Galvanized steel construction

J-bolt assembly includes hex nut, flat and lock washer

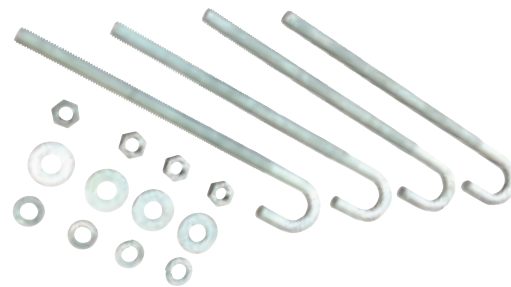

PART #	DESCRIPTION	QUANTITY
JB-8K	8" Galvanized J Bolt Assembly with Nut, Flat and Locks,	Kits of 4

## Crossover Plate Assemblies

### General Specifications

Galvanized steel construction

Includes crossover plate, U-bolts, washers and nuts



PART #	DESCRIPTION	QUANTITY
CP-2020	Crossover Plate Joins 2-3/8" to 2-3/8" OD	1
CP-2025	Crossover Plate Joins 2-3/8" to 2-7/8" OD	1
CP-2030	Crossover Plate Joins 2-3/8" to 3-1/2" OD	1
CP-2040	Crossover Plate Joins 2-3/8" to 4-1/2" OD	1
CP-2525	Crossover Plate joins 2-7/8" to 2-7/8" OD	1
CP-2530	Crossover Plate, Joins 2-7/8" to 3-1/2" OD	1
CP-3030	Crossover Plate Joins 3 1/2" to 3 1/2" OD	1
CP-3040	Crossover Plate, Joins 3-1/2" to 4-1/2" OD	1
CP-4040	Crossover Plate, Joins 4-1/2" to 4-1/2" OD	1

## Crossover Plates

### General Specifications

Hot Dip Galvanized

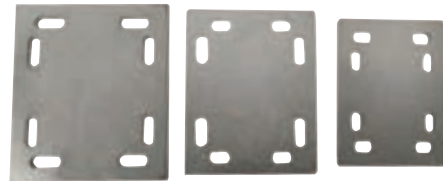

PART #	DESCRIPTION	QUANTITY
SCX2	Crossover Plate Only for 2-3/8 to 2-7/8 OD pipe	1
SCX3	Crossover Plate Only for 2-7/8 – 4-1/2 OD pipe	1
SCX4	Crossover Plate Only for 2-3/8 to 2-7/8 OD and 2-7/8 – 4-1/2 OD	1

## Crossover Plates-Universal

### General Specifications

Hot Dip Galvanized

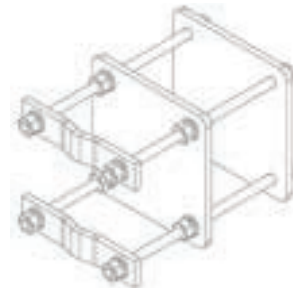

PART #	DESCRIPTION	QUANTITY
XP-ST-U	Crossover Plate, Universal, Joins 2" to 5" Square Tube to 2"	1

## Galvanized Clamps Halves

General Specifications  
 Hot Dip Galvanized



PART #	DESCRIPTION	QUANTITY
V-1.5-5	3/8" x 1-1/2" x 5" Galvanized V-Clamp Half	1
V-1.5-6	3/8" x 1-1/2" x 6" Galvanized V-Clamp Half	1
V-1.5-7	3/8" x 1-1/2" x 7" Galvanized V-Clamp Half	1
V-1.5-858	3/8" x 1-1/2" x 8-5/8" Galvanized V-Clamp Half	1
SCP	1/2" x 1-1/2" x 5-7/8" Galvanized C-Clamp Half	1
ACP	1/4" x 1-1/2" x 6-1/16" Galvanized C-Clamp Half	1
DCP	1/2" x 2" x 8-3/8" Galvanized C-Clamp Half	1
MCP	1/2" x 2" x 11-5/8" Galvanized C-Clamp Half	1

## Pipe-To-Pipe Clamps

General Specifications  
 Galvanized Steel Construction  
 Includes clamp halves, threaded rods, nuts, bolts, washers, locks



PART #	DESCRIPTION	QUANTITY
PC-20-10	Pipe-To-Pipe Clamp Joins Two 1-1/2" to 3-1/2" OD. Light Duty	1 Per Kit
PC-30-10	Pipe-To-Pipe Clamp Joins Two 1-1/2" to 3-1/2" OD. Heavy Duty	1 Per Kit
PC-35-14	Pipe-To-Pipe Clamp Joins Two 2-3/8" to 5" OD.	1 Per Kit
PC-35-18	Pipe to Pipe Clamp Joins Two 2-3/8" to 5" OD 18" Extensions	1 Per Kit

## Waveguide Bridge Support Bracket

### General Specifications

Galvanized steel construction  
 Side-mounted design to support 12" or 24" waveguide bridge  
 U-bolt and hardware included



PART #	DESCRIPTION	QUANTITY
HH-LB12-3	12" Wide for 3-1/2" OD Legs	1
HH-LB24-3	24" Wide for 3-1/2" OD Legs	1

## Trapeze Kit

### General Specifications

Galvanized steel construction  
 Triple tee, three rungs  
 Used with waveguide bridge kits  
 Pre-punched with 3/4" and 7/16" holes



PART #	DESCRIPTION	QUANTITY
TK-T12-3	Triple Tee, 12" Wide, Three Rungs	1
TK-T24-3	Triple Tee, 24" Wide, Three Rungs	1

## Waveguide Ladder Rungs

### General Specifications

Galvanized steel construction  
 11 Gauge  
 Sold individually  
 Designed for buildings or towers as a cable hanging solution



PART #	DESCRIPTION	COVER SIZE	HOLE CONFIGURATION	QUANTITY
LR04	4 Hole Waveguide Ladder Rung	13.5"	(4) 3/4" and (3) 7/16"	1
LR06	6 Hole Waveguide Ladder Rung	19.75"	(6) 3/4" and (5) 7/16"	1
LR09	9 Hole Waveguide Ladder Rung	28.75"	(9) 3/4" and (8) 7/16"	1
LR12	12 Hole Waveguide Ladder Rung	37.75"	(12) 3/4" and (11) 7/16"	1

## Galvanized Ice Bridge Hardware Kit

### General Specifications

Galvanized Steel Construction

Packed in heavy duty wood crates

PART #	DESCRIPTION	QUANTITY
WGB1-HK	12" Ice Bridge Kit Hardware Kit complete	1
WGB2-HK	24" Ice Bridge Kit Hardware Kit complete	1

## Fence Post Caps

### General Specifications

Hot Dipped Galvanized Finish

3-1/2" OD (for ice bridge posts)



PART #	DESCRIPTION	QUANTITY
FP-CAP-35	3-1/2" OD Fence Post Cap	1

## Galvanized Z Brackets

### General Specifications

Galvanized A36 Steel Construction  
 Pre Punched 7/16" and 3/4" mounting  
 holes for coax installation  
 Order hangers and hardware separately

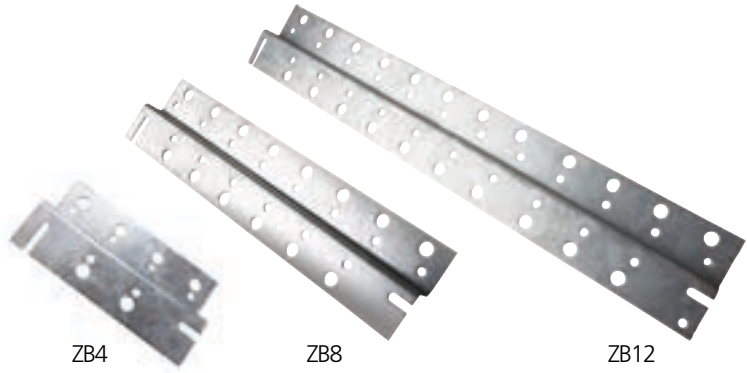

PART #	DESCRIPTION	QUANTITY
ZB4	11" Galvanized Z Bracket, 4 Hole	1
ZB8	23" Galvanized Z Bracket, 8 Hole	1
ZB12	35" Galvanized Z Bracket, 12 Hole	1
ZBHK1	Z Bracket Trapeze Hardware Kit. 2 Galv. 12" Threaded Rod w/ 8 Nuts, 8 flats, 4 Locks and 4 Squares	1
ZBHK2	Z Bracket Trapeze Hardware Kit. 2 Galv. 24" Threaded Rod w/ 12 Nuts, 12 Flats, 6 Locks and 4 Squares	1
ZBHK3	Z Bracket Trapeze hardware kit. 2 Galv. 24" Threaded rod with 18 nuts, 18 flats, 9 locks and 4 squares	1

## Cluster Brackets



PART #	DESCRIPTION	QUANTITY
SCB	Small Cluster Support Bracket 7 lines	1
LCB	Large Cluster Support Bracket 18 lines	1
WMWH6	Round Member Hangers mount to water tank legs and monopoles using 1/2" band, 6 run	10 / pack

## Bond Washers



PART #	DESCRIPTION	QUANTITY
BW4-12	4" x 4" x 0.25" w/ 9/16" Center Hole Backing Plate, Hot Dipped Galvanized	1
BW4-58	4" x 4" x 0.25" w/ 11/16" Center Hole Backing Plate, Hot Dipped Galvanized	1
BW6-58	6" x 6" x 0.25" w/ 11/16" Center Hole Backing Plate, Hot Dipped Galvanized	1

## Cable Ladder Hardware Kits

### General Specifications

Galvanized steel construction

Used to attach cable ladder angle to tower

Kit includes splice hardware, rung attachment hardware and clamp hardware



PART #	DESCRIPTION	QUANTITY
WGLH-10	Cable Ladder Hardware Kit 10' Section	1
WGLH-20	Cable Ladder Hardware Kit 20' Section	1

## Strut

### General Specifications

Galvanized Steel construction  
Pre-punched mounting holes for coax installation  
Order hangers and hardware separately



PART #	DESCRIPTION	QUANTITY
COMSTRUT-78-HDG	7/8" x 1-5/8" Com Strut Alternating 7/16" x 1" Slots and 3/4" Round Holes HDG Finish	1
STRUT-158-HDG	1-5/8" x 1-5/8" Strut, 12 Gauge HDG w / 9/16" x 1-1/8" Slots, 2 on Center	1
STRUT-S-158-HDG	1-5/8" X 10', 13/32" X 3" Slot, Hot Dip Galvanized, Long Slot	1

## Square Galvanized Washers

### General Specifications

Galvanized Steel construction



PART #	DESCRIPTION	QUANTITY
WASH-38	1-5/8" Square Galvanized Washer with 3/8" Center Hole	50 / Pack
WASH-12	1-5/8" Square Galvanized Washer with 1/2" Center Hole	50 / Pack

## Galvanized Spring Nuts

### General Specifications

Galvanized Steel construction  
Spring Coil Individually wrapped in plastic to eliminate damage



PART #	DESCRIPTION	QUANTITY
GSN-14	1/4" Galvanized Spring Nuts	100 / Pack
GSN-38	3/8" Galvanized Spring Nuts	100 / Pack
GSN-12	1/2" Galvanized Spring Nuts	100 / Pack



## Strut End Caps

### General Specifications

Compatible with 7/8" and 1-5/8" strut

Vinyl plastic composition

Safety cap to prevent cuts to installers



EC-R-100



EC-W-100



EC-BK-100

PART #	DESCRIPTION	COLOR	QUANTITY
EC-R-100	End Caps for 1-5/8" Strut	Red	100 / Pack
EC-W-100	End Caps for 1-5/8" Strut	White	100 / Pack
EC-BK-100	End Caps for 1-5/8" Strut	Black	100 / Pack
EC-W-78-100	End Caps for 7/8" x 1-5/8" Strut	White	100 / Pack
EC-BK-78-100	End Caps for 7/8" x 1-5/8" Strut	Black	100 / Pack
EC-R-78-100	End Caps for 7/8" x 1-5/8" Strut	Red	100 / Pack

## Steel Channel Universal Pipe Strap

### General Specifications

Electro Galvanized Finish



PART #	DESCRIPTION	QUANTITY
UNI-1/2-EG	1/2" Universal Pipe Clamp, Electro Galvanized Finish	1
UNI-3/4-EG	3/4" Universal Pipe Clamp, Electro Galvanized Finish	1
UNI-1.0-EG	1" Universal Pipe Clamp, Electro Galvanized Finish	1
UNI-1.25-EG	1.25" Universal Pipe Clamp, Electro Galvanized Finish	1
UNI-1.5-EG	1.5" Universal Pipe Clamp, Electro Galvanized Finish	1
UNI-2.0-EG	2" Universal Pipe Clamp, Electro Galvanized Finish	1
RPC-2.5-EG	2.5" Rigid Pipe Clamp, Electro Galvanized Finish	1
RPC-3.0-EG	3" Rigid Pipe Clamp, Electro Galvanized Finish	1
RPC-3.5-EG	3.5" Rigid Pipe Clamp, Electro Galvanized Finish	1
RPC-4.0-EG	4" Rigid Pipe Clamp, Electro Galvanized Finish	1

## Pipe and Conduit Clamps

### General Specifications

Compatible with 7/8" and 1-5/8" strut

Hot dip galvanized

Rigid pipe clamps work for rigid pipe and PVC only



PART #	DESCRIPTION	QUANTITY
RPC-3/8-HDG	Rigid Pipe Clamp for 3/8" ID Pipe, Hot Dipped Galvanized	1
RPC-1/2-HDG	Rigid Pipe Clamp for 1/2" ID Pipe, Hot Dipped Galvanized	1
RPC-3/4-HDG	Rigid Pipe Clamp for 3/4" ID Pipe, Hot Dipped Galvanized	1
RPC-1.0-HDG	Rigid Pipe Clamp for 1" ID Pipe, Hot Dipped Galvanized	1
RPC-1.25-HDG	Rigid Pipe Clamp for 1-1/4" ID Pipe Hot Dipped Galvanized	1
RPC-1.5-HDG	Rigid Pipe Clamp for 1-1/2" ID Pipe Hot Dipped Galvanized	1
RPC-2.0-HDG	Rigid Pipe Clamp for 2" ID Pipe, Hot Dipped Galvanized	1
RPC-2.5-HDG	Rigid Pipe Clamp for 2.5" ID Pipe, Hot Dipped Galvanized	1
RPC-3.0-HDG	Rigid Pipe Clamp for 3" ID Pipe, Hot Dipped Galvanized	1
RPC-3.5-HDG	Rigid Pipe Clamp for 3.5" ID Pipe, Hot Dipped Galvanized	1
RPC-4.0-HDG	Rigid Pipe Clamp for 4" ID Pipe, Hot Dipped Galvanized	1
RPC-5.0-HDG	Rigid Pipe Clamp for 5" ID Pipe, Hot Dipped Galvanized	1
RPC-6.0-HDG	Rigid Pipe Clamp for 6" ID Pipe, Hot Dipped Galvanized	1
RPC-8.0-HDG	Rigid Pipe Clamp for 8" ID Pipe, Hot Dipped Galvanized	1

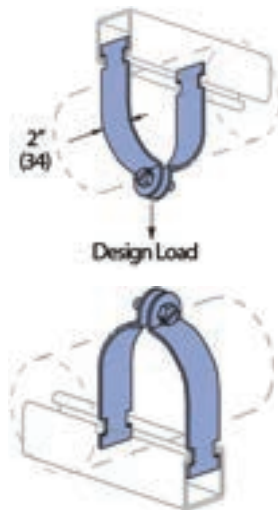

Pipe Size	Weight Allowed
3/8"	10
1/2"	11
3/4"	15
3/4"	15
1"	17
1-1/4"	19
1-1/2"	29
2"	34
2-1/2"	40
3"	47
3-1/2"	62
4"	67
5"	80
6"	102
8"	130

LUGS  
BUSS BARS  
CUSTOMIZABLE  
BUSS BAR FABRICATION  
EXOTHERMIC MOLDS  
ACCESSORIES  
ELIG ELECTRONIC  
IGNITION SYSTEM



Izzy Lugs manufactures a complete line of UL listed lugs, buss bars and exothermic products. Our products provide excellent quality that deliver greater savings while meeting the exacting standards of today's industry. With the rapidly evolving environments in the telecommunication and electrical markets, we are always striving to be a leader in adapting to our customers ever changing needs. Let us know if there is any way we can better serve you!

**Please contact us for more information, email: [scott@izzylugs.com](mailto:scott@izzylugs.com) or call 909-855-3502**





**General Specifications**

- UL and CUL listed
- High conductivity seamless copper construction
- Tin plated
- Long barrel
- CSA certified



**Short Barrel Lugs**

PART #	GAUGE	STUD SIZE	SPACING	COLOR
i14S	#14-#10	#10	n/a	Yellow
i1410-10S	#14-#10	#10	5/8"	Yellow
i1410-14S	#14-#10	1/4"	5/8"	Yellow
i82-10S	#8	#10	5/8"	Red
i62-10S	#6	#10	5/8"	Blue
i62-14S	#6	1/4"	5/8"	Blue
i2S2-10S	#2 Solid/#3 & #4	#10	5/8"	Gray



**One Hole Lugs. No Inspection Window**

PART #	GAUGE	STUD SIZE	COLOR CODE
1410	#14-#10	1/4"	Yellow
8-14	#8	1/4"	Red
6-14	#6	1/4"	Blue
6-38	#6	3/8"	Blue
6-516	#6	5/16"	Blue
2S-38	2 Solid, #3, #4	3/8"	Grey
2-14	#2	1/4"	Brown
2-516	#2	5/16"	Brown
2-38	#2	3/8"	Brown



## Two Hole Lugs. No Inspection Window

PART #	GAUGE	STUD SIZE	HOLE SPACING	COLOR CODE
1410-14	#14-#10	1/4"	5/8" (.625)	Yellow
1410-25-1	#14-#10	1/4"	1"	Yellow
1410-38-1	#14-#10	3/8"	1"	Yellow
82-25-1	#8	1/4"	1"	Red
82-14	#8	1/4"	5/8" (.625)	Red
82-10	#8	#10	5/8" (.625)	Red
62-14	#6	1/4"	5/8" (.625)	Blue
62-34	#6	1/4"	3/4" (.75)	Blue
62-25-1	#6	1/4"	1"	Blue
62-38-1	#6	3/8"	1"	Blue
2S2-14	2 Solid, #3, #4	1/4"	5/8" (.625)	Grey
2S2-34	2 Solid, #3, #4	1/4"	3/4" (.75)	Grey
2S2-38-1	2 Solid, #3, #4	3/8"	1"	Grey
22-14	#2	1/4"	5/8" (.625)	Brown
22-34	#2	1/4"	3/4" (.75)	Brown
22-25-1	#2	1/4"	1"	Brown
22-38-1	#2	3/8"	1"	Brown

(Center to Center)



62-14    2S2-14    22-38-1

## Universal Two Hole Lugs. No Inspection Window

PART #	GAUGE	STUD SIZE	HOLE SPACING	COLOR CODE
82-38U	#8	3/8" Slotted	3/4"-1"	Red
62-38U	#6	3/8" Slotted	3/4"-1"	Blue
2S2-38U	2 Solid, #3, #4	3/8" Slotted	3/4"-1"	Grey
22-38U	#2	3/8" Slotted	3/4"-1"	Brown

(Center to Center)



62-38U    2S2-38U    22-38U



## Barrel Splice Lugs



PART #	GAUGE	LENGTH	COLOR CODE
8BS	#8	2-1/4"	Red
6BS	#6	2-1/4"	Blue
2SBS	2 Solid, #3, #4	2-3/8"	Grey
2BS	#2	2-1/2"	Brown

## One Hole Lugs. WITH Inspection Window

PART #	GAUGE	STUD SIZE	COLOR CODE
i1410	#14-#10	1/4"	Yellow
i8-14	#8	1/4"	Red
i6-14	#6	1/4"	Blue
i6-38	#6	3/8"	Blue
i2S-38	2 Solid, #3, #4	3/8"	Grey
i2-14	#2	1/4"	Brown
i2-516	#2	5/16"	Brown
i2-38	#2	3/8"	Brown



i8-14

i6-14

i2S-38

i2-14

## Two Hole Lugs. WITH Inspection Window

PART #	GAUGE	STUD SIZE	HOLE SPACING	COLOR CODE
i1410-14	#14-#10	1/4"	5/8" (.625)	Yellow
i1410-25-1	#14-#10	1/4"	1"	Yellow
i1410-38-1	#14-#10	3/8"	1"	Yellow
i82-14	#8	1/4"	5/8" (.625)	Red
i82-10	#8	#10	5/8" (.625)	Red
i82-25-1	#8	1/4"	1"	Red
i62-10	#6	#10	5/8" (.625)	Blue
i62-14	#6	1/4"	5/8" (.625)	Blue
i62-25-1	#6	1/4"	1"	Blue
i62-38-1	#6	3/8"	1"	Blue
i2S2-10	2 Solid, #3, #4	#10	5/8" (.625)	Grey
i2S2-14	2 Solid, #3, #4	1/4"	5/8" (.625)	Grey
i2S2-25-1	2 Solid, #3, #4	1/4"	1"	Grey
i2S2-38-1	2 Solid, #3, #4	3/8"	1"	Grey
i22-14	#2	1/4"	5/8" (.625)	Brown
i22-34	#2	1/4"	3/4" (.75)	Brown
i22-25-1	#2	1/4"	1"	Brown
i22-38-1	#2	3/8"	1"	Brown
Fi-22-14	#2 Flex	1/4"	5/8" (.625)	Brown
i4/0-238-1	4/0	3/8"	1"	Purple

(Center to Center)



i82-14

i62-38-1

i2S2-38-1

i22-25-1



## Universal Two Hole Lugs. WITH Inspection Window

PART #	GAUGE	STUD SIZE	HOLE SPACING	COLOR CODE
i1410-14U	#14-#10	1/4", Slotted	1/2" - 5/8"	Yellow
i82-38U	#8	3/8" Slotted	3/4"-1"	Red
i62-38U	#6	3/8", Slotted	3/4" - 1"	Blue
i2S2-38U	2 Solid, #3, #4	3/8", Slotted	3/4" - 1"	Grey
i22-38U	#2	3/8", Slotted	3/4" - 1"	Brown



## 90° (Right Angle) Lugs



PART #	GAUGE	STUD SIZE	DESCRIPTION	COLOR CODE
R8-14	#8	1/4"	One Hole, NO Inspection Window	Red
R8-14i	#8	1/4"	One Hole, WITH Inspection Window	Red
i6-14R	#6	1/4"	One Hole, WITH Inspection Window	Blue
i2S-14R	#2 Solid, #3, #4	1/4"	One Hole, WITH Inspection Window 1/4" hole spacing (center to center)	Grey
i22-14R	#2	1/4"	Two Hole, WITH Inspection Window 5/8" hole spacing (center to center)	Brown
22-14R	#2	1/4"	Two Hole, NO Window. 1/4" hole, 5/8" spacing (center to center)	Brown
22-34R	#2	1/4"	Two Hole. NO Window. 1/4" hole, 3/4" hole spacing (center to center)	Brown
62-14R	#6	1/4"	Two Hole, NO window. 1/4" hole, 5/8" spacing (center to center)	Blue
Fi-22-14R	#2 Flex	1/4"	Two Hole, WITH Inspection window. 1/4" hole, 5/8" spacing (center to center)	Brown



## Cable Tray Jumpers

### General Specifications

9", 6 AWG THHN Green Wire.

2 hole configuration.

1/4" or 3/8" stud sizes.

Connection is weatherproofed with UL listed heat shrink

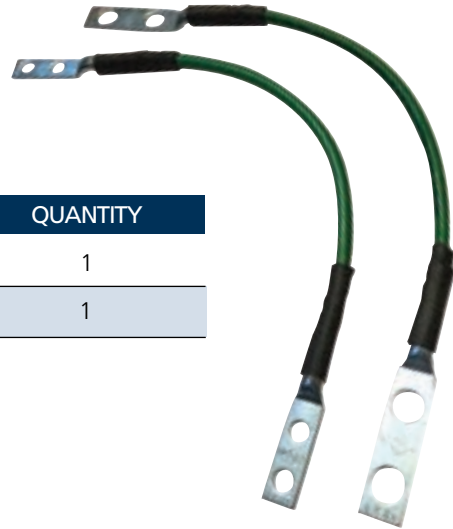

PART #	LUG TYPE	STUD SIZE	HOLE SPACING	QUANTITY
CTJ6238	2 Hole	1/4"	5/8"	1
CTJ6214	2 Hole	3/8"	1"	1

## Ratchet Crimping Tool

### General Specifications

Color coded rotating die

Die includes 5 cavities: #10-#14, #2, 2 solid (includes #3 & #4), #6 and #8 awg



PART #	DESCRIPTION
IL-CRIMPER	Hand Ratcheting Tool



## Custom Buss Bar Fabrication

### General Information

- Custom tinned copper, copper and galvanized bus bars
- Produced in-house to your specifications
- Fast turnaround
- Custom stamping
- Custom shapes and configurations
- CAD services available

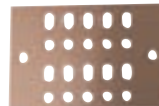
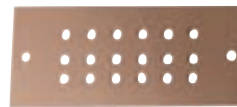



## Tinned Copper Buss Bars

### General Specifications

Solid 1/4" thick copper buss bars

Universal hole pattern accepts 2 hole lugs with 3/4" and/or 1" spacing

Custom patterns and hole sizes available

PART #	DESCRIPTION	SIZE
GBU1426-T	Tinned Copper Buss Bar	2"x 6"
GBU1428-T	Tinned Copper Buss Bar	2"x 8"
GBU14210-T	Tinned Copper Buss Bar	2"x 10"
GBU14212-T	Tinned Copper Buss Bar	2"x 12"
GBU14214-T	Tinned Copper Buss Bar	2"x 14"
GBU1446-T	Tinned Copper Buss Bar	4"x 6"
GBU1448-T	Tinned Copper Buss Bar	4"x 8"
GBU14410-T	Tinned Copper Buss Bar	4"x 10"
GBU14412-T	Tinned Copper Buss Bar	4"x 12"
GBU14414-T	Tinned Copper Buss Bar	4"x 14"
GBU14420-T	Tinned Copper Buss Bar	4"x 20"
GBU14424-T	Tinned Copper Buss Bar	4"x 24"



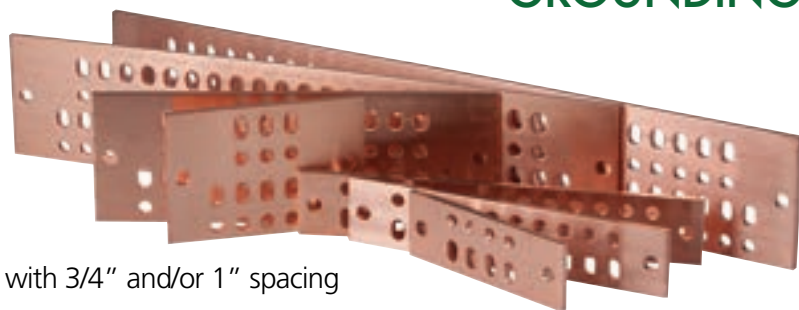

## Copper Buss Bars

### General Specifications

Solid 1/4" thick copper buss bars

Universal hole pattern accepts 2 hole lugs with 3/4" and/or 1" spacing

Custom patterns and hole sizes available

PART #	DESCRIPTION	SIZE
GBU1426	Solid Copper Buss Bar	2" x 6"
GBU14210	Solid Copper Buss Bar	2" x 10"
GBU14212	Solid Copper Buss Bar	2" x 12"
GBU14214	Solid Copper Buss Bar	2" x 14"
GBU1446	Solid Copper Buss Bar	4" x 6"
GBU1448	Solid Copper Buss Bar	4" x 8"
GBU14410	Solid Copper Buss Bar	4" x 10"
GBU14412	Solid Copper Buss Bar	4" x 12"
GBU14414	Solid Copper Buss Bar	4" x 14"
GBU14420	Solid Copper Buss Bar	4" x 20"
GBU14424	Solid Copper Buss Bar	4" x 24"
GBU14219-RACK	Copper Bus Bar For Rack Mounting	2" x 19"
GBU14223-RACK	Copper Bus Bar For Rack Mounting	2" x 23"

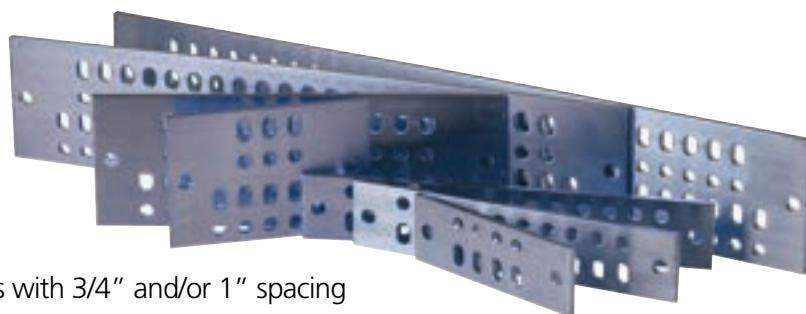

## Galvanized Buss Bars

### General Specifications

Solid 1/4" thick galvanized steel buss bar

Universal hole pattern accepts 2 hole lugs with 3/4" and/or 1" spacing

Custom patterns and hole sizes available

PART #	DESCRIPTION	SIZE
GBU14206-G	Galvanized Steel Bus Bar	2" x 6"
GBU14406-G	Galvanized Steel Bus Bar	4" x 6"
GBU14412-G	Galvanized Steel Bus Bar	4" x 12"
GBU14424-G	Galvanized Steel Bus Bar	4" x 24"



## Rack Mount Buss Bar Hardware Kits

### General Specifications

19" Rack mounting hardware kits

PART #	DESCRIPTION	QUANTITY
BB-HK-ISO	19" Rack mounting hardware kit, Includes (2)Single Space Insulator for Rack Mount Buss Bars (4)12-14x3/4 Phillips Pan Head Screw t/f thread (4) Insulator Bushing, Nylon, .500 OD x .260 ID x .093 Tall	Kit of 1
BB-HK-ISO-2	19" Rack mounting hardware kit, Includes (2)Double Space Insulator for Rack Mount Buss Bars (4)12-14x3/4 Phillips Pan Head Screw t/f thread (4) Insulator Bushing, Nylon, .500 OD x .260 ID x .093 Tall	Kit of 1
BB-HK-ISO-3	19" Rack mounting hardware kit, Includes (2)Triple Space Insulator for Rack Mount Buss Bars (4)12-14x3/4 Phillips Pan Head Screw t/f thread (4) Insulator Bushing, Nylon, .500 OD x .260 ID x .093 Tall	Kit of 1
BB-HK-ISO-4	19" Rack mounting hardware kit, Includes (2) 4 times Space Insulator for Rack Mount Buss Bars (4)12-14x3/4 Phillips Pan Head Screw t/f thread (4) Insulator Bushing, Nylon, .500 OD x .260 ID x .093 Tall	Kit of 1



BB-HK



BB-HK-TOWER

## Buss Bar Hardware Kit

PART #	DESCRIPTION	QUANTITY
BB-HK	Universal Ground Bar Hardware Kit	10 /Case
BB-HK-TOWER	Bus Bar Hardware Kits for Tower Mounting-- No Brackets	10 / Case
BB-HK-TD	Theft Deterrent Hardware Kits- 4-3/8" x 3/4" Bolts with Tool	1
CHERRY-38	3/8" UL Listed Insulator	1

## Shelter Buss Bar Kits

General Specifications  
 UL Listed

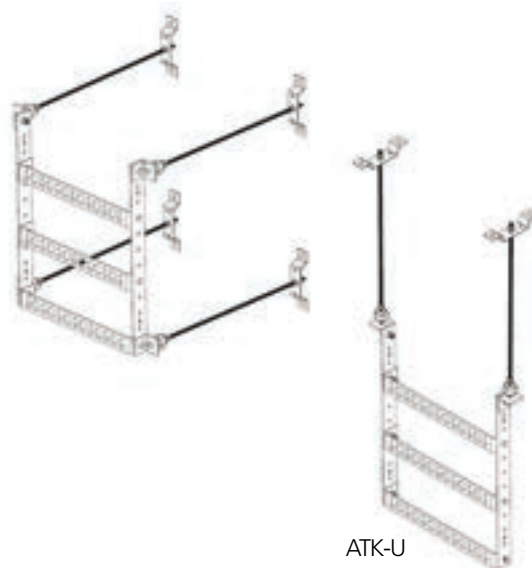

ATK-U

PART #	DESCRIPTION	QUANTITY
ATK-U	Arrestor Trapeze Buss Bars, 3 Tier 18" Wide (For 4 Hole wide Entry Panels)	1
ATK-28U	Arrestor Trapeze Buss Bars, 3 Tier 28" Wide (For 6 Hole wide Entry Panels)	1
ATK-U-RUNG	Copper Ladder Rung for ATK-U, for Four Hole Wide Entry Panel, 18" wide	1
ATK-28U-RUNG	Copper Ladder Rung for ATK-28U, for Six Hole Wide Entry Panel, 28" wide	1
ETMAGS	Grounding Stand-Off Bracket. 5" OD for (8) 3/8" 2 Hole Lug	1



## IzzyWeld Exothermic Starter Kit

### Includes:

- Storage Box
- Mold, Parallel Stack, #2 Solid, #65 Shot
- Mold, 45 Deg Down Vert. Pipe 1.5-4OD, #2 Solid, #45 Shot
- Mold, Bus Bar Edge 1/4 Thick, #2 Solid, #65 Shot
- Mold, Straight Up Vert. Pipe 1.5-4OD, #2 Solid, #65 Shot
- Mold, T Run & Tap #2 Solid to #2 Solid, #45 Shot
- Mold, 45 Deg Down Flat Vert Steel, #2 Solid, #45 Shot
- Mold, Flat Horiz Steel, w/ Handle, #2 Solid, #45 Shot
- Mold, Ground Rod T-Over 5/8 Rod, #2 Solid, #90 Shot
- Mold, Straight Down Vert. Pipe 1.5-4OD, #2 Solid, #65 Shot
- Mold, Straight Down Flat Vert Steel, #2 Solid, #65 Shot
- Mold, Straight Up Vert. Pipe 1.5-4OD, #2 Strand, #65 Shot
- Mold Handle w/ Flint Gun
- Mold Cleaning Spade
- Mold Handle and Chain Kit w/ Flint Gun
- Mold Putty –1lb Brick
- Exothermic Disc for #45 & #65 Shots, Pack of 100
- Exothermic Disc for #90 & #115 Shots, Pack of 100
- Mold Cleaning Brush
- #45 Shots – Case of 20
- #65 Shots – Two Cases of 20
- #90 Shots – Case of 10

PART #	DESCRIPTION
IZ-STARTER	Izzy Weld Starter Kit



## IzzyWeld Exothermic Weld Metal

General Specifications

UL Listed



PART #	DESCRIPTION	QUANTITY
iZ-45	#45 Shots	20 per Case
iZ-65	#65 Shots	20 per Case
iZ-90	#90 Shots	10 per Case
iZ-115	#115 Shots	10 per Case
iZ-150	#150 Shots	10 per Case
iZ-200	#200 Shots	10 per Case
iZ-250	#250 Shots	10 per Case



## Steel Disks

PART #	DESCRIPTION	QUANTITY
DISK-S	Steel Disks for #45 and #65 Shots	Pack of 100
DISK-M	Steel Disks for #90 and #115 Shots	Pack of 100

## Exothermic Molds

General Specifications

Popular Telecom Molds

Custom molds in 48 hours or less

UL Listed Exothermic System

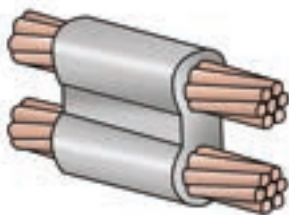

**WP-2AS-2AS**  
#2 Solid  
#2 Solid Parallel Connection  
#65 Shot

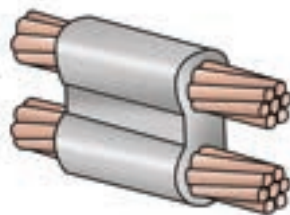

**WP-30-2AS**  
#2 Solid  
3/0 run  
#115 Shot



**SVES-2AS-1.5-4**  
#2 Solid  
1.5" to 4" Vertical Pipe  
#45 Shot

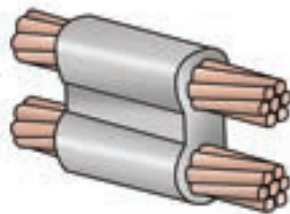

**WP-40-2AS**  
#2 Solid  
Parallel Stack 4/0 Run  
#150 Shot



**PT 2AS-.25**  
#2 Solid  
0.25" Thick Copper Bar  
#65 Shot



**PT 2A-.25**  
#2 Stranded  
0.25" Buss Bar  
#45 Shot

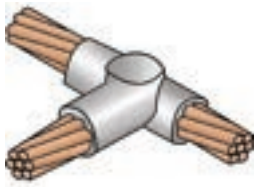

**WT 2AS-2AS**  
 #2 Solid  
 #2 Solid Tee Connection  
 #45 Shot

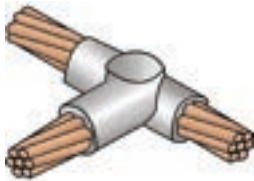

**WT-2/0A-2/0A**  
 2/0  
 T Run and Tap, 2/0 to 2/0  
 #90 Shot

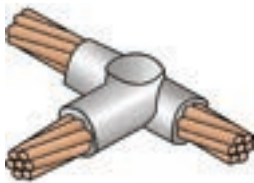

**WT-4/0A-2A**  
 T Run & Tap 4/0 to  
 #2 Stranded  
 #90 Shot

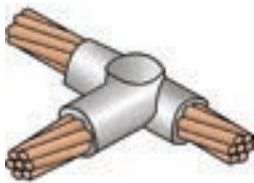

**WT-2/0A-2A**  
 T Run & Tap 2/0 to  
 #2 Stranded  
 #65 Shot

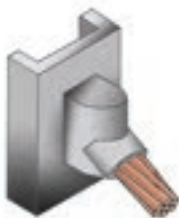

**SVES 2AS**  
 #2 Solid  
 Vertical Flat Steel  
 #45 Shot

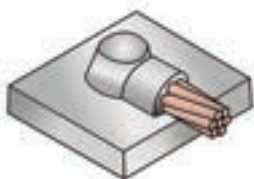

**SHEA 2AS**  
 #2 Solid  
 Horizontal Flat  
 #45 Shot

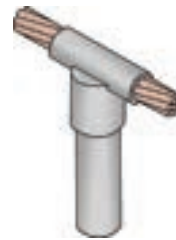

**GET-12-2AS**  
 #2 Solid  
 1/2" Ground Rod  
 #65 Shot

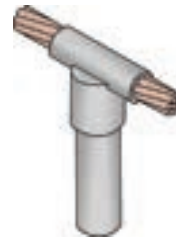

**GET 15-2AS**  
 #2 Solid  
 Ground Rod  
 #90 Shot

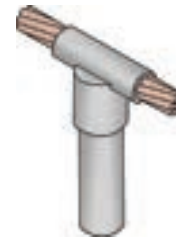

**GET-15-2/0A**  
 Ground Rod T  
 Over 5/8" Rod, 2/0 wire  
 #90 Shot



**SVED 2AS-1.5-4**  
 #2 Solid Drop  
 1.5" to 4" Pipe  
 #65 Shot



**SVEU 2AS-1.5-4**  
 #2 Solid  
 Vertical Pipe  
 #65 Shot



**SVEU 2A-1.5-4**  
 #2 Riser  
 1.5" to 4" Pipe  
 #65 Shot



**GEE-15-2AS**  
 Solid Horizontal  
 90 Degree End to 5/8"  
 Vertical Ground Rod  
 #65 Shot

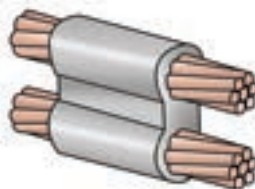

**WP-2/0A-2/0A**  
 Mold, Parallel Stack  
 2/0 Run  
 #115 Shot

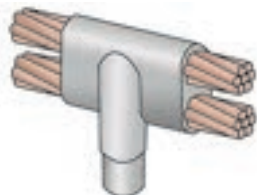

**GEP-12-2AS**  
 #2 Solid wire to 1/2"  
 Ground Rod Mold  
 #115 Shot

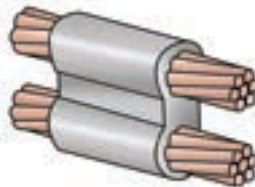

**WP-2/0A-2AS**  
 #2 Solid  
 2/0 Stranded Wire Through  
 to Parallel #2 Solid Wire  
 through  
 #90 Shot



**SVES-2AS-1.5-4**  
 #2 Solid  
 1.5" to 4" Vertical Pipe  
 #45 Shot

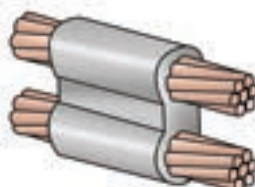

**WP4/0A-2AS**  
 4/0 Parallel  
 4/0 Run to #2 Solid  
 #150 Shot



**SVED 2AS**  
 #2 Solid Drop  
 Vertical Flat  
 #65 Shot

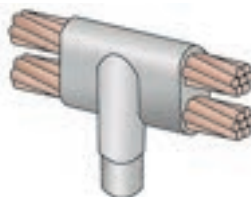

**GEP-15-2AS**  
 #2 Solid  
 Parallel through over 5/8  
 Ground Rod  
 #150 Shot



**SVEU-2AS**  
 #2 Solid  
 Vertical Flat Up  
 #65 Shot



**WL-2AS-2AS**  
 #2 Solid to #2 Solid  
 Running Tap  
 # Shot

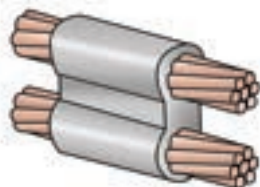

**WP3/0A-2AS**  
 3/0 Parallel  
 3/0 Run to #2 Solid  
 #115 Shot

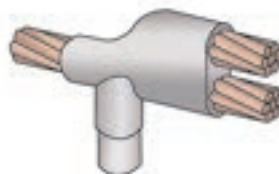

**GEY-15-2AS**  
 Ground Rod Y-Over 5/8"  
 Rod, (2) #2 Solid  
 #115 Shot

Only the most common molds listed. Custom molds are available in 48 hours.

## Handle Clamp

General Specifications  
 Compliant with all standard molds



PART #	DESCRIPTION
CL-3	Regular Handle Clamp



PART #	DESCRIPTION
CL-3CHAIN	Chain Handle Clamp



PART #	DESCRIPTION
CL-3MAGNET	Magnet Handle Clamp

## Flint Igniter



PART #	DESCRIPTION
IGNITER	Flint Igniter

## Mold Scraper

General Specifications  
Used in removing slag from molds



PART #	DESCRIPTION
SCRAPER	Slag Removal Tool

## Mold Brush

General Specifications  
Used in removing slag from molds



PART #	DESCRIPTION
BRUSH	Mold Cleaning Brush

## Putty

PART #	DESCRIPTION
MOLD PUTTY	Putty



# LEADING THE WAY IN THE WIRELESS TELECOM AND ELECTRICAL INDUSTRY



PEMBROKE, NEW HAMPSHIRE

603-546-7117

909-855-3502

[www.IzzyIndustries.com](http://www.IzzyIndustries.com)

[www.IzzyLugs.com](http://www.IzzyLugs.com)